

Unloading table 1550 short rollers

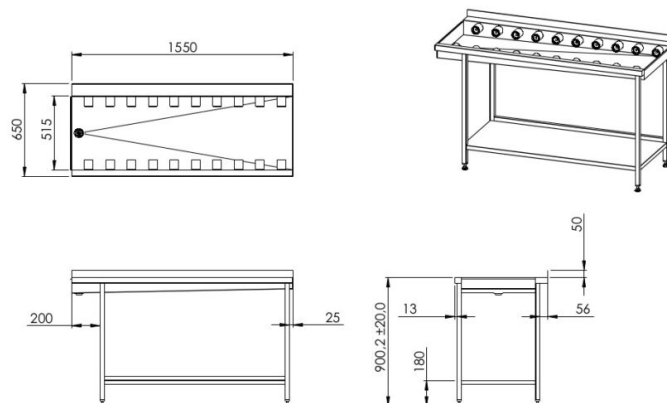

- **Product code:** JPL 1550 short rollers



- stainless steel worktop
- splash guard at the back of the table with standard height of 50 mm (can be ordered with maximum height of 200 mm)
- table has dishwasher interface (NB! interface corresponding to dishwasher model – customer provides relevant information)
- bottom of bath slopes towards the drain connection
- drain hole Ø50
- stainless steel square tube work table frame (30 x 30 mm)
- adjustable feet allow adjusting height of ±20 mm

Unloading table accessories available on order:

- perforated bottom shelf
- without shelf

RESTMEC

Unloading table 1550 short rollers

- debris screen
- ball valve