

Warm serving buffet TREND LTV T 6GN

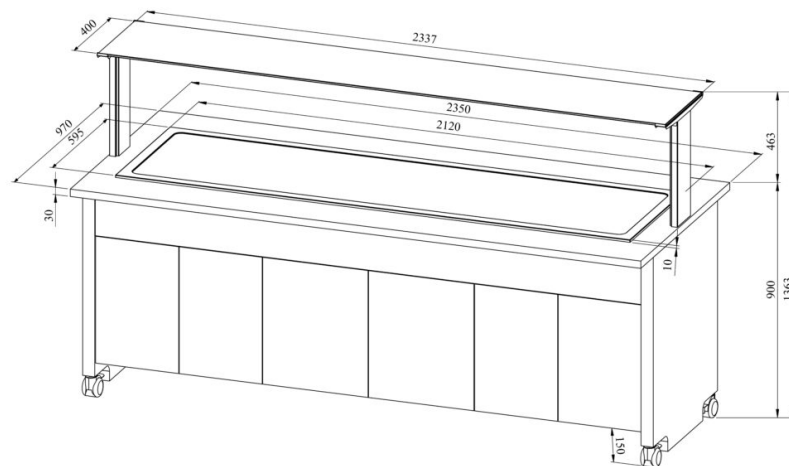

- **Product code:** TREND LTV T 6GN
- **Dimensions, mm (w*d*h):** 2350*970*1363
- **Drop In soetasapind (laius*sügavus*kõrgus):** 2120*595*300
- **Operating temperature:** +30...+95
- **Degree of protection:** IP44
- **Capacity (kW):** 0,5
- **Frequency (Hz):** 50
- **Voltage (V):** 220 - 230



- warm serving buffet is intended for short-term storage of foodstuffs at +30°C to +95°C
- „Drop-In warm“ plate can be mounted on tabletop
- manually adjusted operating temperature
- upper shelf with lighting, clear glass splash guard
- warm plate fits GN 1/1 (6 pcs)
- buffet is on wheels, allowing easier transport (2pcs lockable wheels)
- neutral cupboard at the lower part of the buffet
- illustrative image shows buffet with UTP G upper shelves
- **Accessories available on order:**
 - various upper shelves (see the product group of upper and hand out shelves)

[Technical drawing, PDF-file](#)

RESTMEC