

# Warm serving buffet TREND LTV 2GN

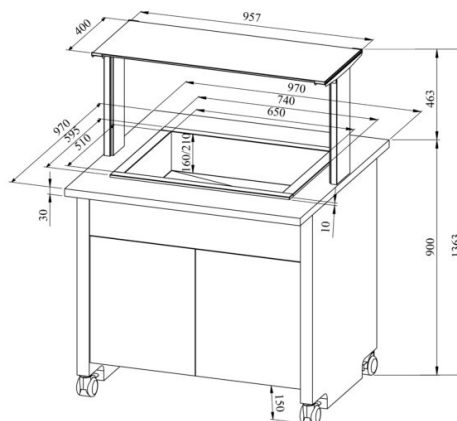

- **Product code:** TREND LTV 2GN
- **Dimensions, mm (w\*d\*h):** 970\*970\*1363
- **Drop In soesüvend (laius\*sügavus\*kõrgus):** 740\*595\*300
- **Operating temperature:** +30...+95
- **Degree of protection:** IP44
- **Capacity (kW):** 1,1
- **Frequency (Hz):** 50
- **Voltage (V):** 220 - 230



- warm serving buffet is intended for short-term storage of foodstuffs at +30°C to +95°C
- Drop-In warm basin can be mounted on tabletop
- manually adjusted operating temperature
- upper shelf with lighting, clear glass splash guard
- basin, fits containers GN 1/1-150 (2 pcs)
- drain connection with valve at the bottom of basin
- buffet is on wheels, allowing easier transport (2pcs lockable wheels)
- neutral cupboard at the lower part of the buffet
- illustrative image shows buffet with UTP G upper shelve
- **Accessories available on order:**
  - various upper shelves (see the product group of upper and hand out shelves)
  - basin, depth 200mm

[Technical drawing, PDF-file](#)

**RESTMEC**