

# Cold serving buffet TREND KTV T 2GN

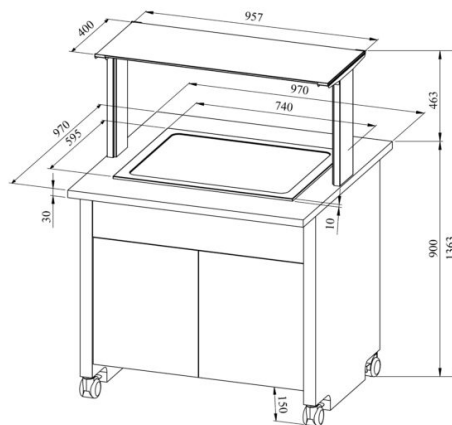

- **Product code:** TREND KTV T 2GN
- **Dimensions, mm (w\*d\*h):** 970\*970\*1363
- **Drop In külmtasapind (laius\*sügavus\*kõrgus):** 740\*595\*400
- **Operating temperature:** +2 .... +8
- **Degree of protection:** IP44
- **Refrigerant:** R290
- **Capacity (kW):** 0,4
- **Frequency (Hz):** 50
- **Voltage (V):** 220 - 230



- cold serving buffet is intended for short-term storage of foodstuffs at +2 °C to +8 °C
- „Drop-In“ cold plate can be mounted on tabletop
- mechanical thermostat
- upper shelf with lighting, clear glass splash guard
- stainless steel flat surface, fits containers GN 1/1 (2 pcs)
- buffet is on wheels, allowing easier transport (2 pcs lockable wheels)
- buffet has a neutral cupboard in lower part
- illustrative image shows buffet with UTP G upper shelve
- **Accessories available on order:**
  - various upper shelves (see the product group of upper and hand out shelves)

[Technical drawing, PDF-file](#)

**RESTMEC**