

Counter for work table SBRP2

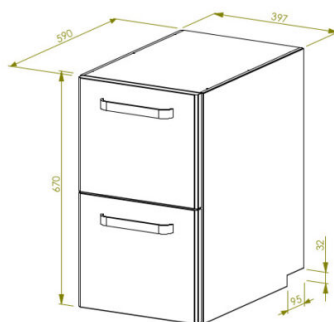

- **Product code:** SBRP2
- **Dimensions, mm (w*d*h):** 397*590*670



- made of stainless steel
- 2 drawers

[Technical drawing, PDF-file](#)

RESTMEC