

Work table module cupboard UB KSK 403

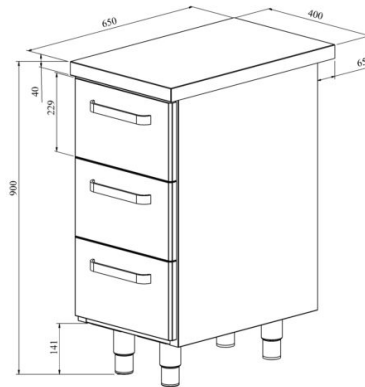

- **Product code:** UB KSK 403
- **Dimensions, mm (w*d*h):** 400*650*900



- made of stainless steel
- module with counter
- placement of modules can be easily changed
- modules can be fitted under a single work top, they can also be used as an extension for a cold counter
- drawers fit GN containers
- adjustable feet allow adjusting work table height in the range of 855–915 mm
- **Accessories for work table module available on order:**
 - single plate for the modules (various modules can be combined under one work top)
 - sink
 - option to install back wall (specify in order)

[Technical drawing, PDF-file](#)