

Drop-In warm basin DI L 3GN

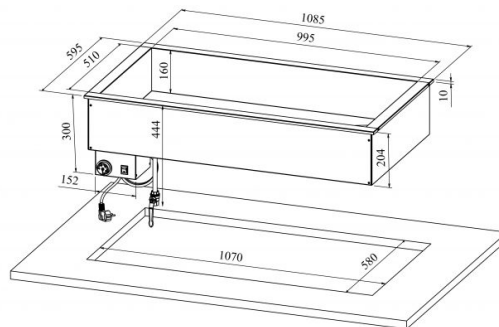

- **Product code:** DI L 3GN
- **Dimensions, mm (w*d*h):** 1085*595*300
- **Operating temperature:** +30 +90
- **Degree of protection:** IP44
- **Capacity (kW):** 1,65
- **Frequency (Hz):** 50
- **Voltage (V):** 220 - 230



- warm basin is intended for short-term distribution of food at +30°C to +90°C
- made of stainless steel
- warm basin fits GN 1/1-150 (3 pc)
- can be mounted on tabletop or frame
- drain connection with valve at the bottom of basin
- thermostat-adjusted temperature
- **Accessories available on order:**
 - various upper shelves (see the product group of upper and hand out shelves)
 - basin, depth 210mm

[Technical drawing, PDF-file](#)