

Drop-In cold basin 5GN

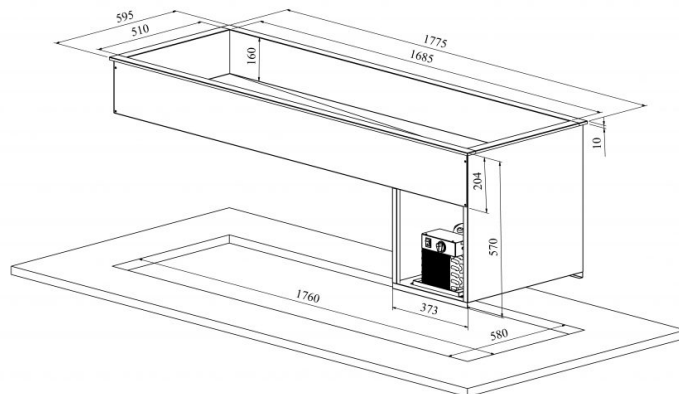

- **Product code:** DI K 5GN
- **Dimensions, mm (w*d*h):** 595*1775*570/204
- **Operating temperature:** +4 +8
- **Degree of protection:** IP44
- **Refrigerant:** R290
- **Capacity (kW):** 0,4
- **Frequency (Hz):** 50
- **Voltage (V):** 220 - 230



- cold basin is intended for short-term distribution of chilled food at +4°C to +8°C
- made of stainless steel
- cold basin fits GN 1/1-150 (5 pcs)
- can be mounted on tabletop or frame
- stand must be open or well ventilated
- mechanical thermostat
- basin has drain connection
- **Accessories available on order:**
 - various upper shelves (see the product group of upper and hand out shelves)
 - basin, depth 210mm

[Technical drawing, PDF-file](#)

RESTMEC