

# Drop-In cold basin 2GN

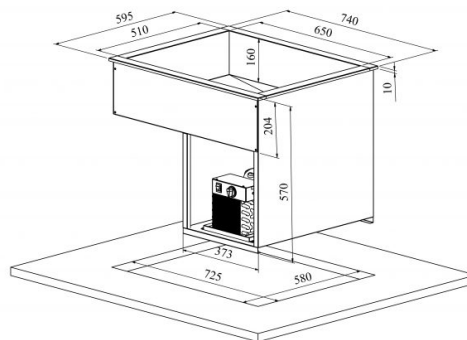

- **Product code:** DI K 2GN
- **Dimensions, mm (w\*d\*h):** 595\*740\*570/204
- **Operating temperature:** +4 .... +8
- **Degree of protection:** IP44
- **Refrigerant:** R290
- **Capacity (kW):** 0,4
- **Frequency (Hz):** 50
- **Voltage (V):** 220 - 230



- cold basin is intended for short-term distribution of chilled food at +4°C to +8°C
- made of stainless steel
- cold basin fits GN 1/1-150 (2 pcs)
- can be mounted on tabletop or frame
- stand must be open or well ventilated
- mechanical thermostat
- basin has drain connection
- **Accessories available on order:**
  - various upper shelves (see the product group of upper and hand out shelves)
  - basin, depth 210mm

[Technical drawing, PDF-file](#)

**RESTMEC**