

# Warm serving buffet LTV 6GN

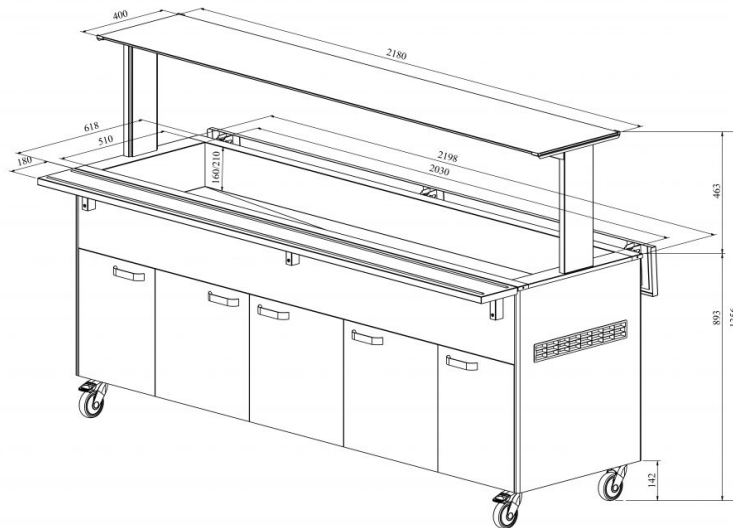

- **Product code:** LTV 6GN
- **Dimensions, mm (w\*d\*h):** 2200\*620\*893
- **Operating temperature:** +30...+95
- **Degree of protection:** IP44
- **Capacity (kW):** 3,3
- **Frequency (Hz):** 50
- **Voltage (V):** 220 - 230



- warm serving buffet is intended for short-term storage of foodstuffs at +30°C to +95°C
- manually adjusted operating temperature
- upper shelf with lighting, clear glass splash guard
- fold-down auxiliary surfaces
- basin, fits containers GN 1/1-150 (6pcs)
- buffet is on wheels, allowing easier transport (2pcs lockable wheels)
- neutral cupboard at the lower part of the buffet
- illustrative image shows buffet with UTP G upper shelves
- **Accessories available on order:**
  - various upper shelves (see the product group of upper and hand out shelves)
  - basin, depth 200mm
  - stainless steel socket
  - kit for connecting side surfaces

[Technical drawing, PDF-file](#)

**RESTMEC**