

Market serving buffet MBKL 3

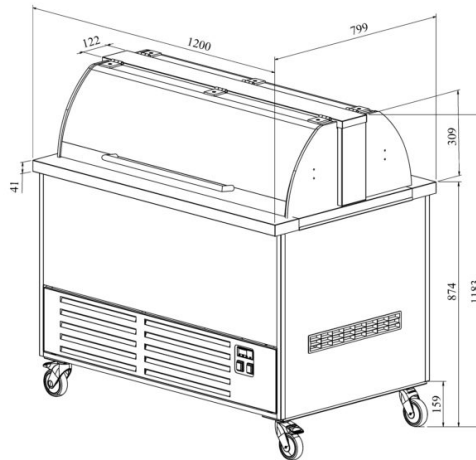

- **Product code:** MBKL 3
- **Dimensions, mm (w*d*h):** 1200*799*1183
- **Operating temperature:** +2 +8
- **Degree of protection:** IP44
- **Refrigerant:** -
- **Capacity (kW):** 0,4
- **Frequency (Hz):** 50
- **Voltage (V):** 220 - 230



- market serving buffet is intended for short-term storage of foodstuffs at +2°C to +8°C
- digital adjustment of operating temperature (digital temperature display)
- automatic defrost system
- silently closing buffet doors (gas strut)
- buffet doors serve as splash guard
- basin, fits GN containers 1/1-150 (3 pcs)
- ventilated cooling system
- buffet is on wheels, allowing easier transport (2 pcs lockable wheels)
- laminated casing
- **Accessories available on order:**
 - end basket/baskets for sides (see the gallery)

[Technical drawing, PDF-file](#)

RESTMEC