

# Cold serving buffet KTV T 3GN

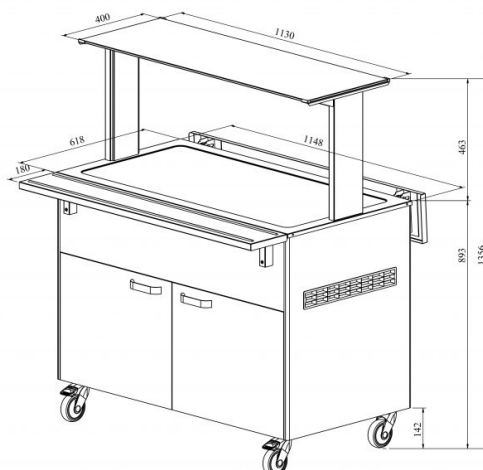

- **Product code:** KTV T 3GN
- **Dimensions, mm (w\*d\*h):** 1150\*620\*1356
- **Operating temperature:** +2 .... +8
- **Degree of protection:** IP44
- **Refrigerant:** R290
- **Capacity (kW):** 0,4
- **Frequency (Hz):** 50
- **Voltage (V):** 220 - 230



- cold serving buffet is intended for short-term storage of foodstuffs at +2 °C to +8 °C
- mechanical thermostat
- upper shelf with lighting, clear glass splash guard
- fold-down auxiliary surfaces
- stainless steel flat surface, fits containers GN 1/1 (3 pcs)
- buffet is on wheels, allowing easier transport (2 pcs lockable wheels)
- buffet has a two-door neutral cupboard in lower part
- set includes dividers for smaller GN containers
- illustrative image shows buffet with UTP G upper shelve
- **Accessories available on order:**
  - various upper shelves (see the product group of upper and hand out shelves)
  - stainless steel socket
  - kit for connecting side surfaces

[Technical drawing, PDF-file](#)

**RESTMEC**