

Bain-marie with open base LHJ 800

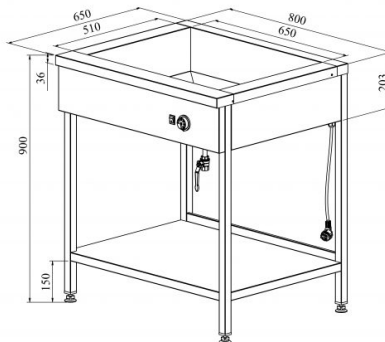

- **Product code:** LHJ 800
- **Dimensions, mm (w*d*h):** 800*650*900
- **Operating temperature:** +30...+95
- **Degree of protection:** IP44
- **Capacity (kW):** 1,1
- **Frequency (Hz):** 50
- **Voltage (V):** 220 - 230



- made of stainless steel
- one individual insulated basin, fits 2x GN 1/1-150 (containers not included)
- basin has drain connection
- thermostat-adjusted temperature range from +30 °C to +95 °C
- open shelf at the bottom
- basin with round corners – easier to clean
- adjustable feet allow adjusting height of ±10 mm
- **Accessories available on order:**
 - basin, fits GN 2/1-200

[Technical drawing, PDF-file](#)