

Cold basin with open stand KAJ 1600

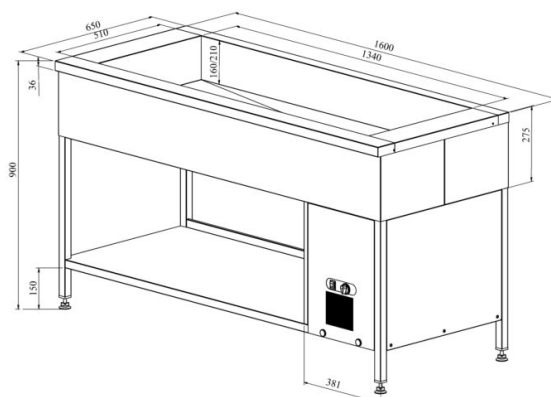

- **Product code:** KAJ 1600
- **Dimensions, mm (w*d*h):** 1600*650*900
- **Operating temperature:** +2 +8
- **Degree of protection:** IP44
- **Refrigerant:** R290
- **Capacity (kW):** 0,4
- **Frequency (Hz):** 50
- **Voltage (V):** 220 - 230



- cold basin is intended for storage of foodstuffs at +2 °C to +8 °C
- made of stainless steel
- one individual insulated cold basin (static), fits 4x GN 1/1-150 (containers not included)
- basin has drain connection
- open shelf at the bottom
- adjustable feet allow adjusting height of ±10mm
- **Accessories available on order:**
 - basin, fits GN 1/1-200
 - various upper and hand out shelves (see the product group of upper and hand out shelves)

[Technical drawing, PDF-file](#)

RESTMEC