

Cold counter for food VLE 1631

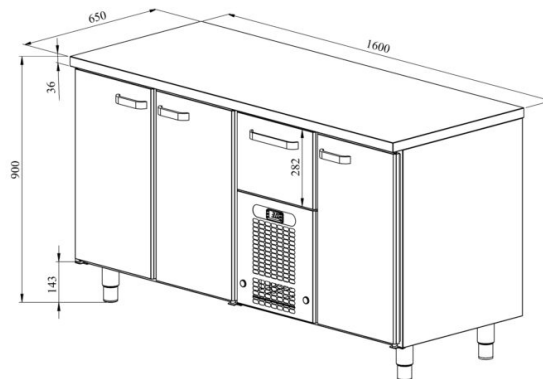

- **Product code:** VLE 1631
- **Dimensions, mm (w*d*h):** 1600x650x900
- **Operating temperature:** +2 +8
- **Degree of protection:** IP44
- **Refrigerant:** R290
- **Capacity (kW):** 0,4
- **Frequency (Hz):** 50
- **Voltage (V):** 220 - 230



- cold counter is intended for storage of foodstuffs at +2 °C to +8 °C
- made of stainless steel
- digital temperature display
- automatic defrost system
- quickly replaceable refrigerating compressor
- drawers for GN containers move on self-locking telescopic rails
- drawers open 110%, making it easier to place GN containers in the drawer
- drawer 282mm (1 pc): GN 1/1-200
- counter has 8 pairs of rails for GN containers or shelf (see the gallery)
- adjustable feet allow adjusting height in the range of 855–915mm
- **Accessories available on order:**
 - liners for drawers
 - stainless steel sliding rails for drawers

[Technical drawing, PDF-file](#)

RESTMEC