

Cold counter with basin PAB 1609

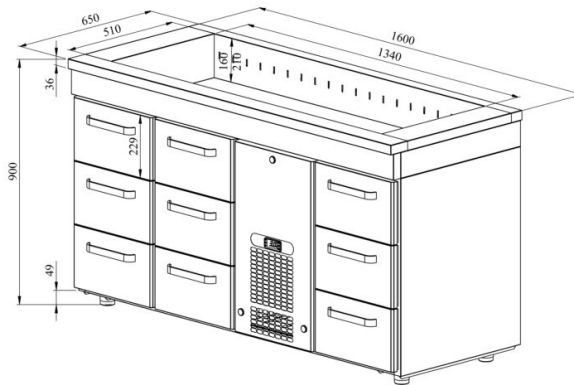

- **Product code:** PAB 1609
- **Dimensions, mm (w*d*h):** 1600x650x900
- **Operating temperature:** +2 +8
- **Degree of protection:** IP44
- **Refrigerant:** R290
- **Capacity (kW):** 0,4
- **Frequency (Hz):** 50
- **Voltage (V):** 220 - 230



- cold counter is intended for storage of foodstuffs and beverages at +2 °C to +8 °C
- made of stainless steel
- digital temperature display
- automatic defrost system
- quickly replaceable refrigerating compressor
- worktop has cold basin for bottles, fits GN 1/1-150 (4 pcs)
- drawer 229mm (9 pcs): GN 1/1-150
- drawer on telescopic rails opens 110%
- adjustable feet allow adjusting height of +25 mm
- **Accessories available on order:**
 - liners for drawers
 - stainless steel sliding rails for drawers

[Technical drawing, PDF-file](#)

RESTMEC