

Cold counters for pizza KLE 1630

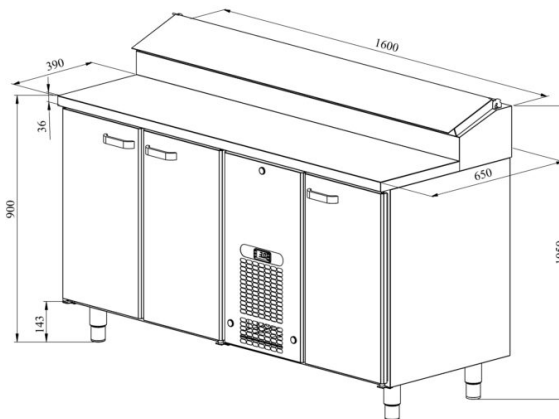

- **Product code:** KLE 1630
- **Dimensions, mm (w*d*h):** 1600x650x900
- **Operating temperature:** +2 +8
- **Degree of protection:** IP44
- **Refrigerant:** R290
- **Capacity (kW):** 0,4
- **Frequency (Hz):** 50
- **Voltage (V):** 220 - 230



- cold counter is intended for storage of foodstuffs at +2 °C to +8 °C
- made of stainless steel
- digital temperature display
- automatic defrost system
- quickly replaceable refrigerating compressor
- elevated cold basin at the back of the worktop, fits 9x (GN 1/6-150)
- cold basin has stainless steel cover
- counter has 8 pairs of rails for GN containers or shelves (see the gallery)
- adjustable feet allow adjusting height in the range of 855–915 mm

[Technical drawing, PDF-file](#)

RESTMEC