

Cold counter for barmen BM 2008 GD

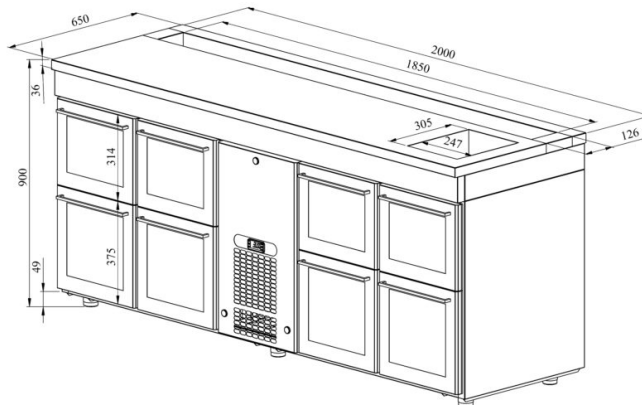

- **Product code:** BM 2008 GD
- **Dimensions, mm (w*d*h):** 2000x650x900
- **Operating temperature:** +2 +8
- **Degree of protection:** IP44
- **Refrigerant:** R290
- **Capacity (kW):** 0,6
- **Frequency (Hz):** 50
- **Voltage (V):** 220 - 230



- cold counter is intended for storage of beverages at +2 °C to +8 °C
- made of stainless steel
- digital temperature display
- automatic defrost system
- quickly replaceable refrigerating compressor
- worktop has a bottle holder and cold basin for ice cubes that fits GN 1/2-150 (with drain connection)
- drawer 314mm (4 pcs): (internal dimensions: 520mm x 303mm x (h) 255mm)
- drawer 375mm (4 pcs): (internal dimensions: 520mm x 303mm x (h) 335mm)
- drawer allows placing bottles or beverage crates
- drawer on telescopic rails opens 110%
- glass face of the drawer ensures good visibility of products
- LED lighting
- adjustable feet allow adjusting height of +20mm
- **Accessories available on order:**

RESTMEC

Cold counter for barmen BM 2008 GD

- stainless steel sliding rails for drawers

[Technical drawing, PDF-file](#)