

# Mixbufee TREND MIX 3GN

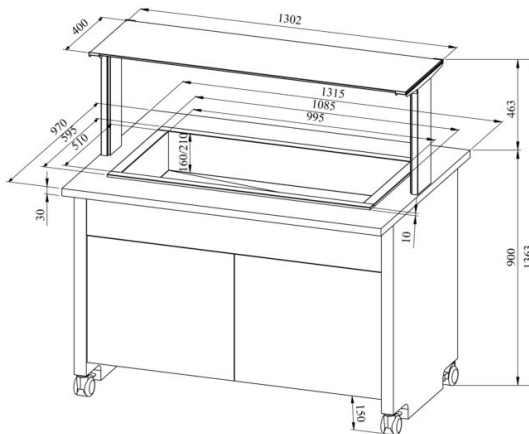

- **Product code:** TREND MIX 3GN



- TREND MIX BUFFET can combine 2 products from the Drop-In product selection
- Drop-In product selection: DIK, DIKT, DIL, DILT, DILBM
- mix buffet ensures with various solutions the short-term preservation of foodstuff
- both warm and cold basins can be combined – solutions are tailored to your needs! FOR EXAMPLE: TREND MIX 3GN DIL 1GN + DIK 2GN
- the Drop-In basin can be mounted into worktop
- Drop-In warm basin can be mounted on tabletop
- upper shelf with lighting, clear glass splash guard
- buffet is on wheels, allowing easier transport (2pcs lockable wheels)
- neutral cupboard at the lower part of the buffet
- illustrative image shows buffet with UTP G upper shelve
- **Accessories available on order:**
  - various upper shelves (see the product group of upper and hand out shelves)
  - basin, depth 200mm

[Technical drawing, PDF-file](#)