

Cold plate with open stand KTJ 2000

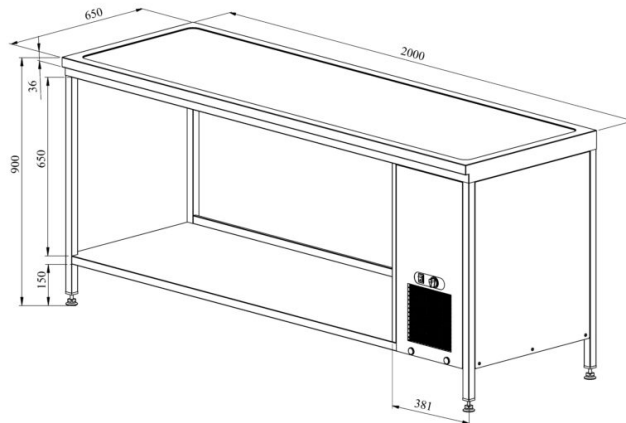

- **Product code:** KTJ 2000
- **Dimensions, mm (w*d*h):** 2000*650*900
- **Operating temperature:** +2 +8
- **Degree of protection:** IP44
- **Refrigerant:** R290
- **Capacity (kW):** 0,4
- **Frequency (Hz):** 50
- **Voltage (V):** 220 - 230



- made of stainless steel
- warm plate fits GN 1/1 (5 pcs)
- cold serving buffet is intended for short-term storage of foodstuffs at +2 °C to +8 °C
- mechanical thermostat
- stainless steel square tube work table frame (30 x 30 mm)
- adjustable feet allow adjusting height of ± 20 mm
- **Accessories available on order:** various upper shelves (see the product group of upper and hand out shelves)

[Technical drawing, PDF-file](#)